

KAMAMI

KAmoPCA9533



Rev. 20200923102606

Źródło: <https://wiki.kamamilabs.com/index.php/KAmoPCA9533>

Spis treści

Basic features and parameters	1
Standard equipment	2
Electrical schematic	3
Output description - Pmod standard connector	4
Output description - KAMAMI standard connector	5
Dimensions	8
External links	9

Description

[KAmoPCA9533](#) is a module with LED dimmer from NXP. The board is equipped with a Pmod I2C standard connector and a KAMAMI connector, that allow to easy connection of the module to the evaluation kits. Due to its small dimensions, the product can be used in many development projects, while the Pmod loop connector allows to connect the boards in the series.

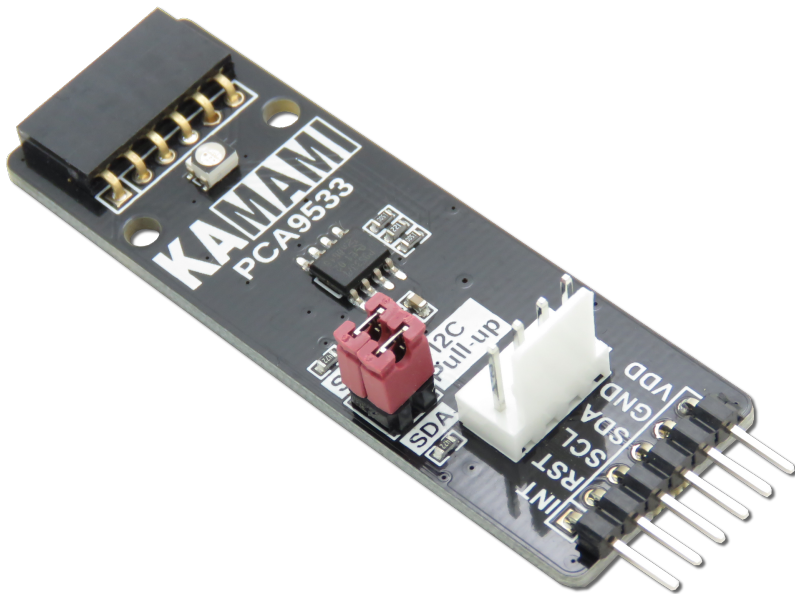

Basic features and parameters

- PCA9533 chip from NXP
 - 4 LED brightness control
 - Two programmable blink rates and duty cycles coupled to the output PWM with frequency from 0.591 Hz to 152 Hz
 - 256 brightness steps
 - Pins not used as LED drivers can be used as regular GPIOs
 - Internal oscillator
 - I2C-bus interface
- LED RGB OSTBMAS2C1A
- Connector compatible with the Pmod standard, allows serial connection of Pmod I2C modules
- The connector complies with the KAMAMI standard
- Embedded jumpers activating pull-up on I2C bus lines
- Possibility to supply voltage from 2.3...5.5V
- Mounting holes with a diameter of 2.5mm
- Dimensions: 61.2mm x 20.3mm x 10mm

Standard equipment

Code	Description
KAmoPCA9533	• Assembled and launched module

Electrical schematic

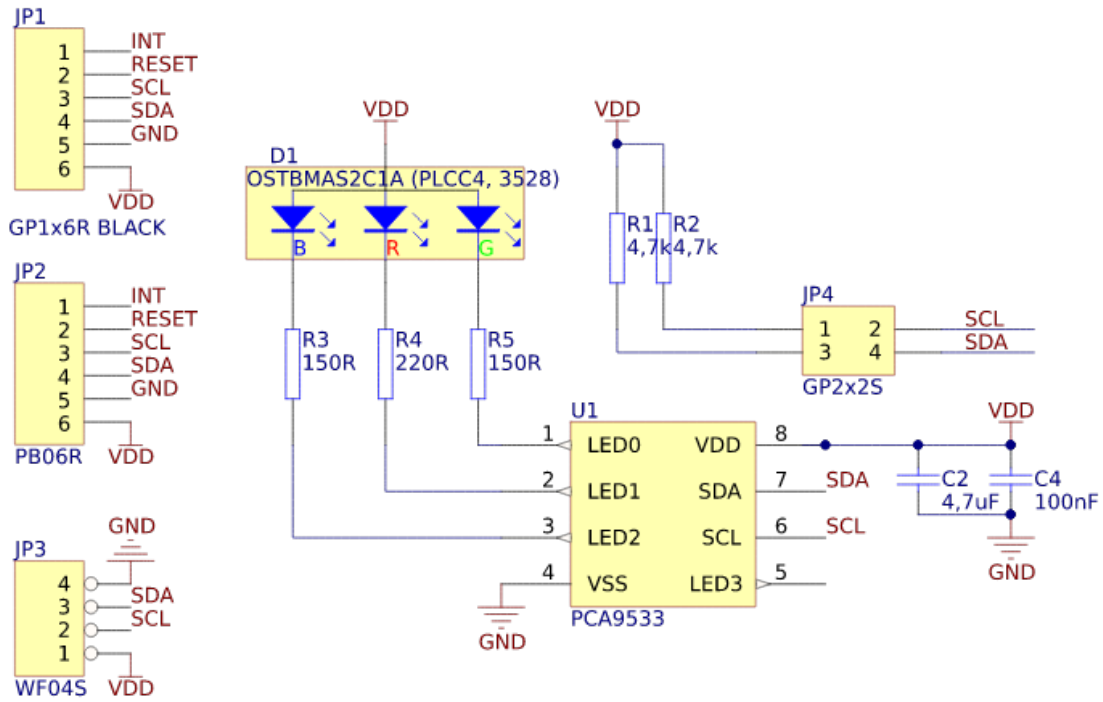



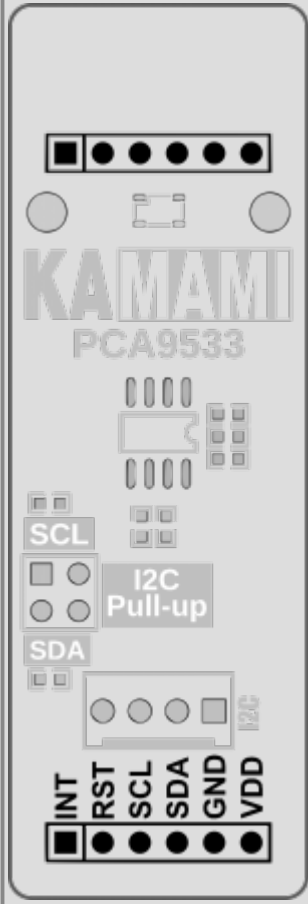

Output description - Pmod standard connector

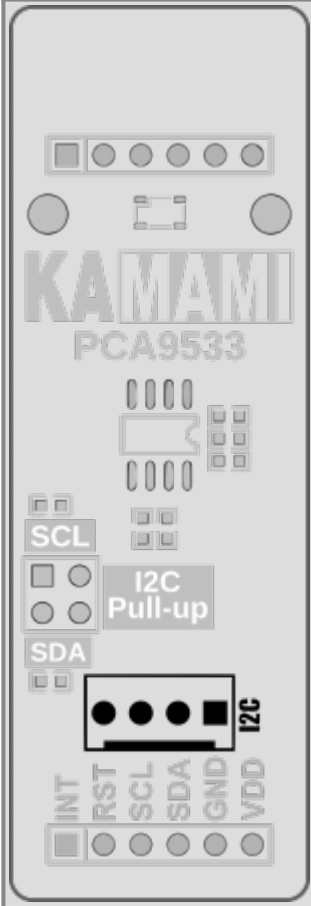

The diagram shows a Pmod standard connector for the KAMAMI PCA9533 module. It features a 6-pin header at the top and bottom. The top header has pins labeled INT, RST, SCL, SDA, GND, and VDD. The bottom header has pins labeled INT, RST, SCL, SDA, GND, and VDD. The module also includes an I2C Pull-up resistor and an I2C connector.

JP1 (male connector)	JP2 (female connector)	Function
VDD	VDD	Power supply of module (max. 3,6 V)
GND	GND	
SDA	SDA	Data line of I2C bus
SCL	SCL	Clock line of I2C bus
RST	RST	-
INT	INT	-

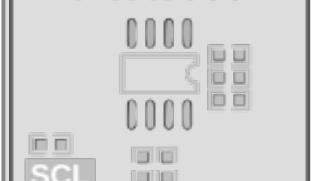
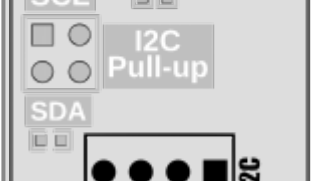
Output description - KAMAMI standard connector

	Pin number	Function
	1 (VDD_5V)	Power supply of module (max. 5,5 V)
	2 (SCL)	Clock line of I2C bus
	3 (SDA)	Data line of I2C bus
	4 (GND)	Ground

I2C bus lines

The KAmoPCA9533 module is equipped with jumpers allowing to connect pull-up resistors to the positive power pole to the I2C bus line. The jumpers give the possibility of independent enabled of the pull-up for the SDA and SCL lines.

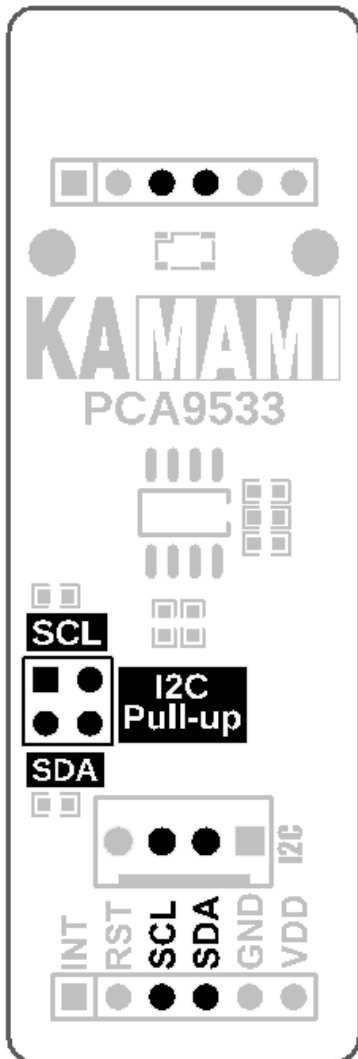

LED RGB

The KAmoPCA9533 module is equipped with an RGB OSTBMA52C1A diode with a common anode. The diode is connected to the LED0, LED1 and LED2 pins of the PCA9533 chip with the use of current limiting resistors.

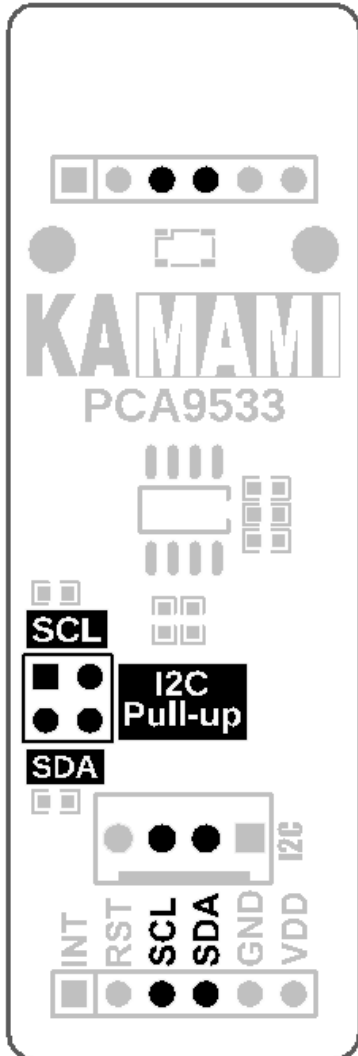

Dimensions

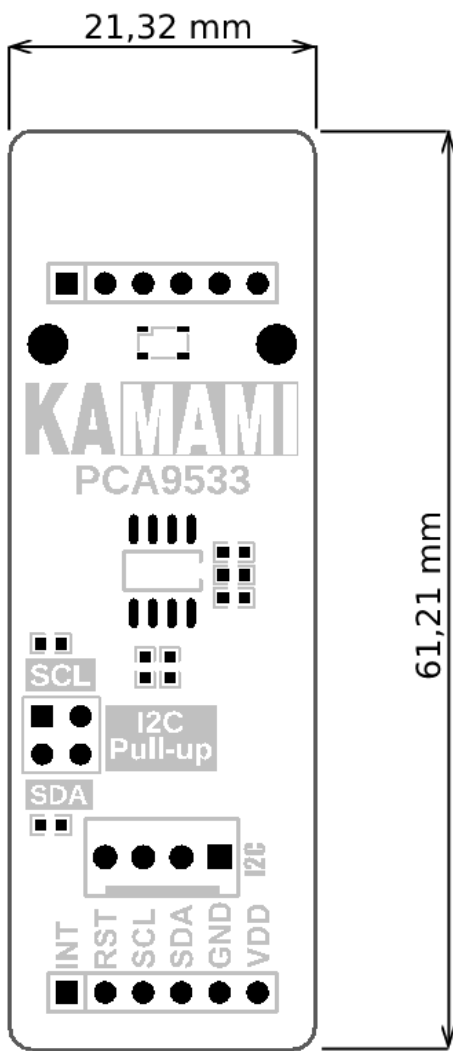

External links

- [PCA9533 IC datasheet](#)
- [OSTBMAS2C1A LED datasheet](#)
- [Library for PCA9533 \(C language\)](#)



Zastrzegamy prawo do wprowadzania zmian bez uprzedzenia.

Oferowane przez nas płytki drukowane mogą się różnić od prezentowanej w dokumentacji, przy czym zmianom nie ulegają jej właściwości użytkowe.

BTC Korporacja gwarantuje zgodność produktu ze specyfikacją.

BTC Korporacja nie ponosi odpowiedzialności za jakiegokolwiek szkody powstałe bezpośrednio lub pośrednio w wyniku użycia lub nieprawidłowego działania produktu.

BTC Korporacja zastrzega sobie prawo do modyfikacji niniejszej dokumentacji bez uprzedzenia.